

# DOCUMENT REPONSE

*Dans l'espace réponse réservé à chaque partie  
le candidat identifiera clairement le numéro de la question à laquelle il répond.*

## I- ANALYSE FONCTIONNELLE [Q1 : FAST]

Fonctions techniques (voir annexe 1)	Solutions techniques (à compléter)
FT1	
FT2	
FT311	
FT312	
FT321	

Fonctions techniques (voir annexe 1)	Solutions techniques (à compléter)
FT33	
FT41	
FT51	
FT61	
FT71	

## II- ASSERVIR LES DEPLACEMENTS DE LA PLATE-FORME [Q2 à Q11]

### Question 2

**Question 3**

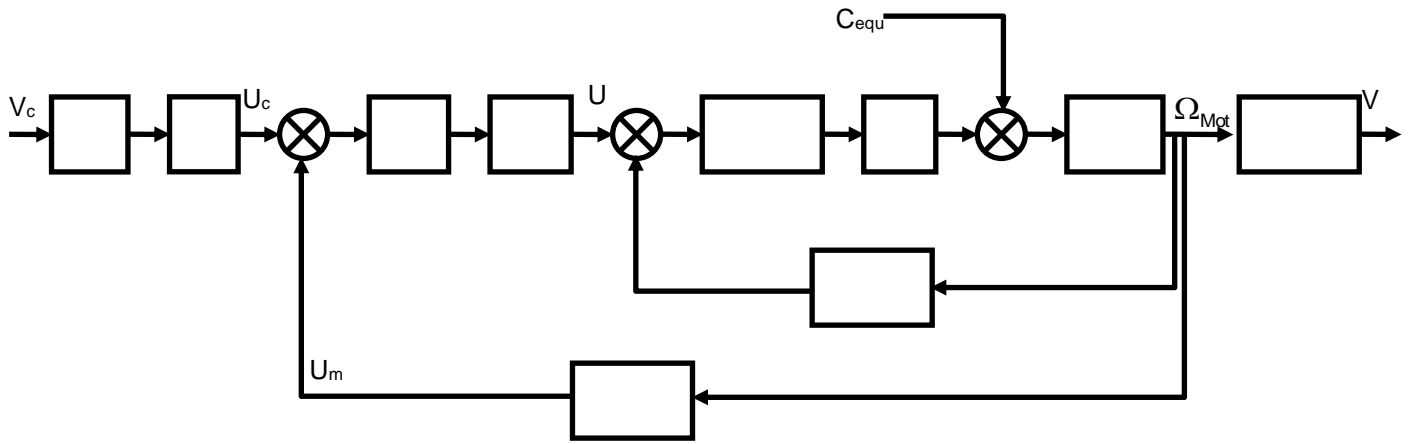

**Question 4**

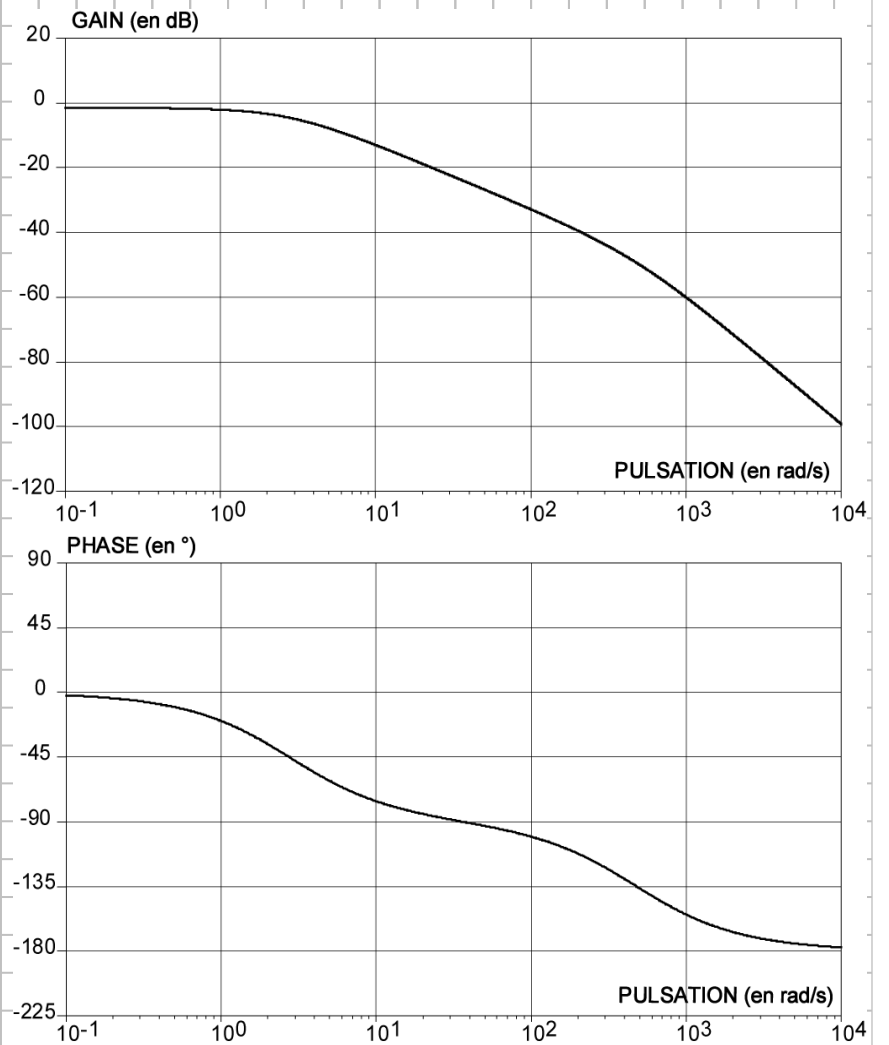

**Question 5**

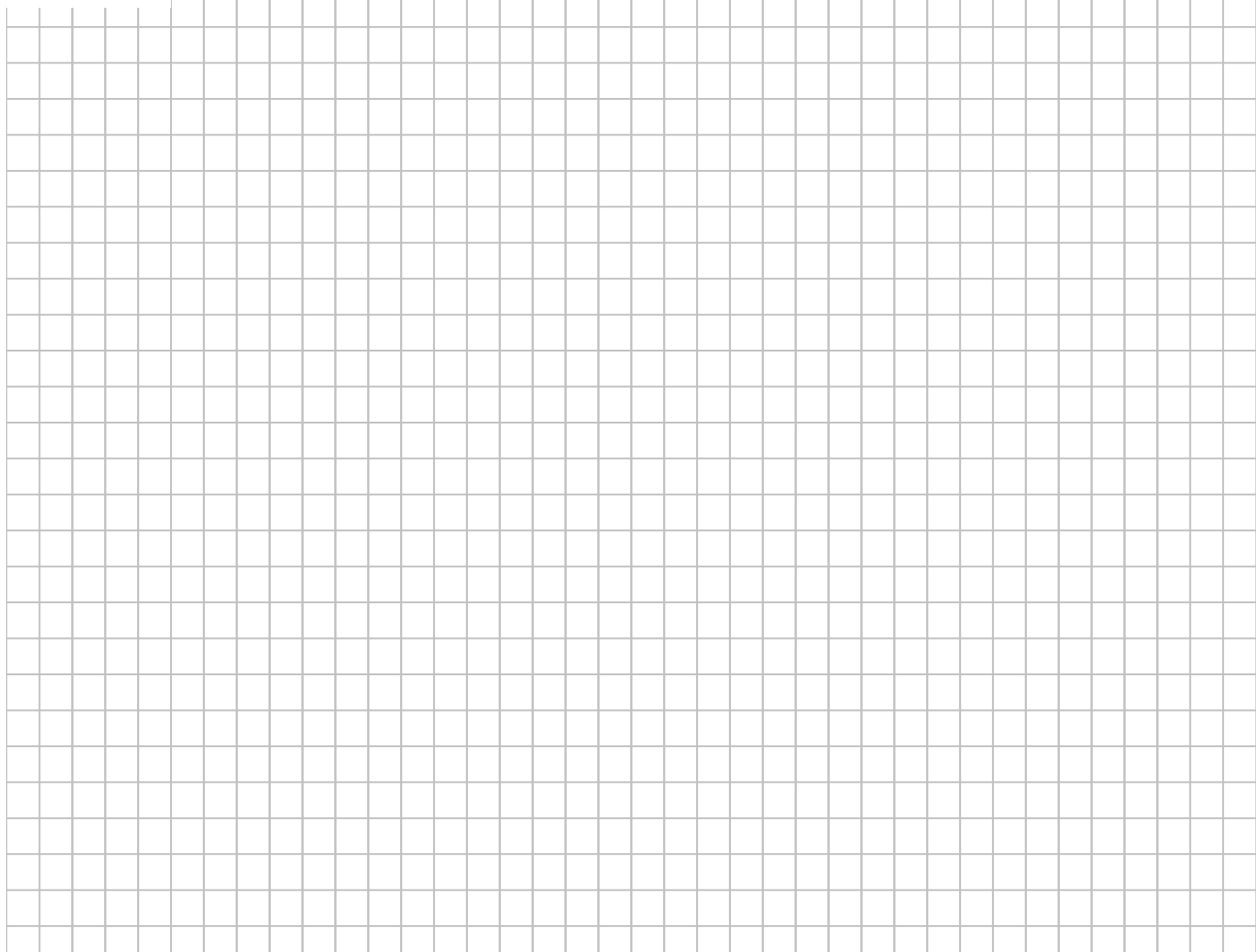

**Question 6**

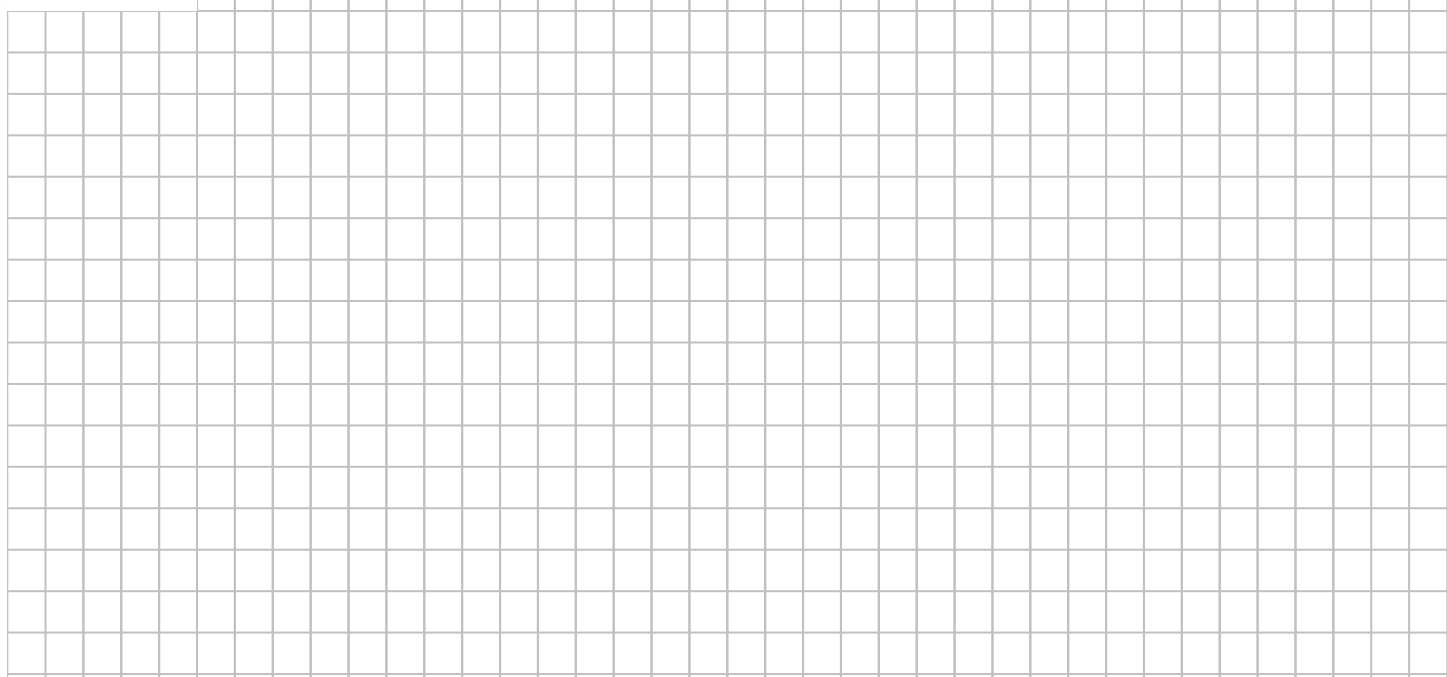

Question 7

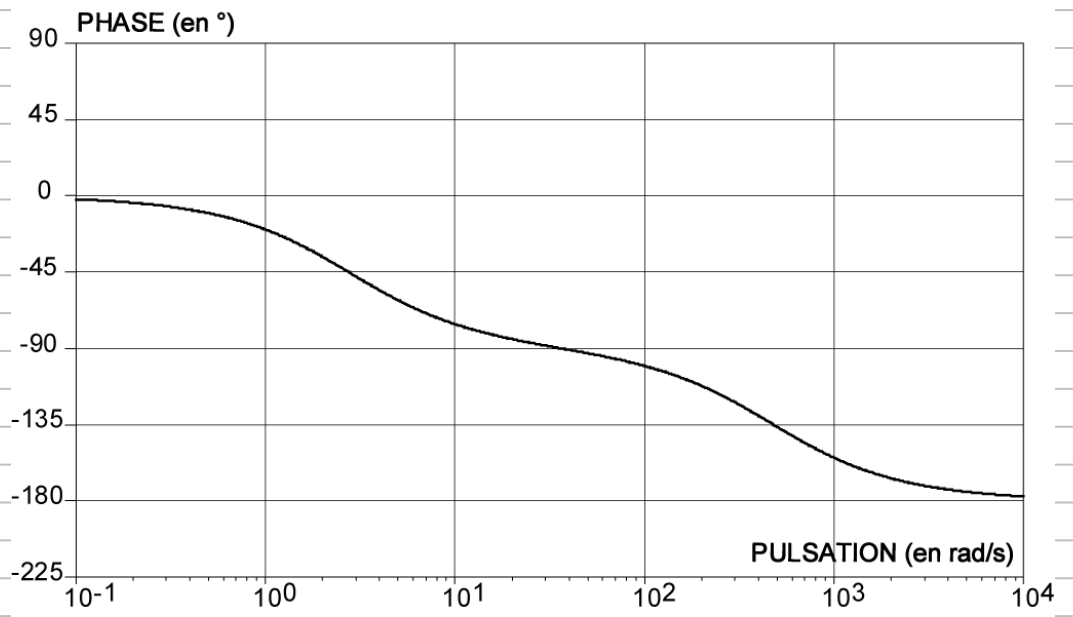
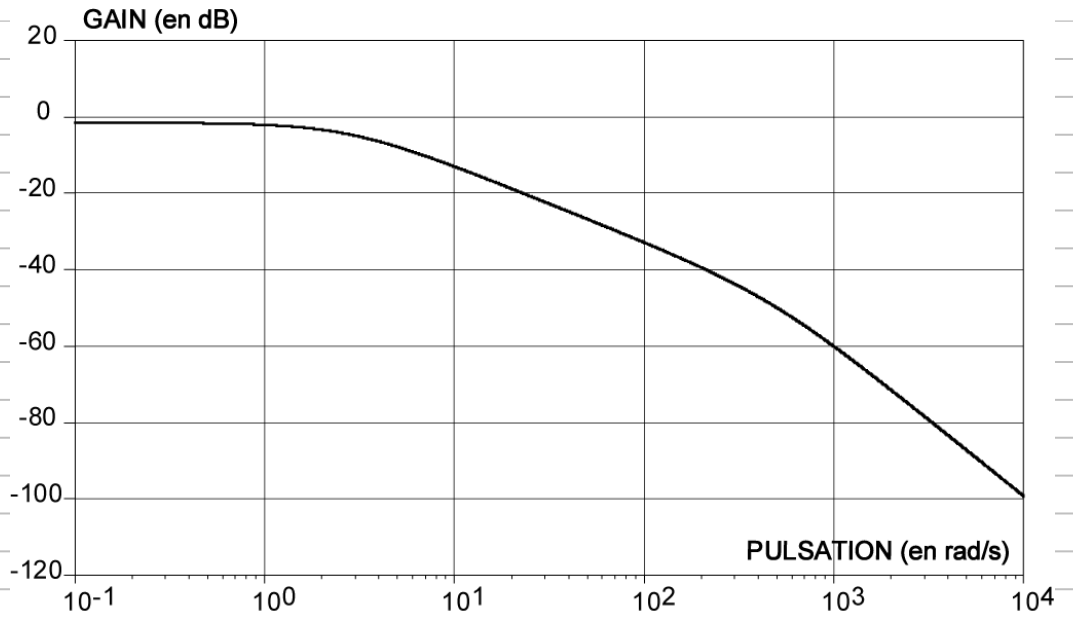

Question 8 :

Question 9 :

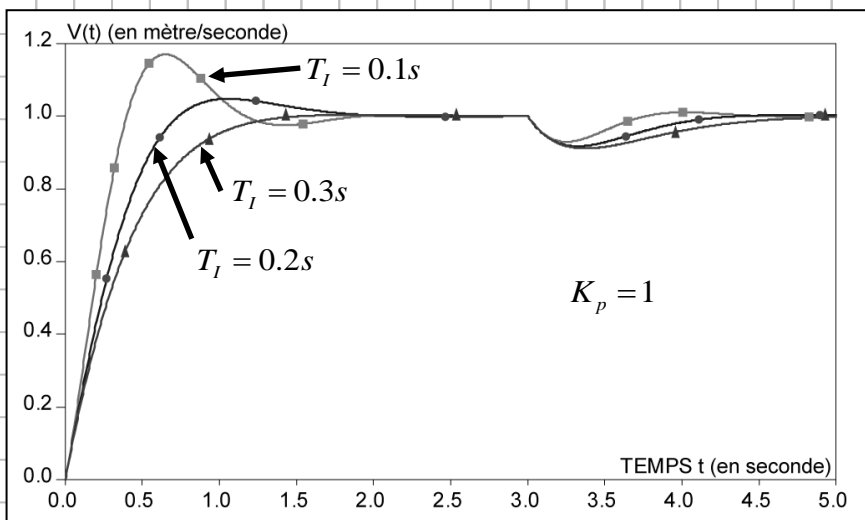

Question 10

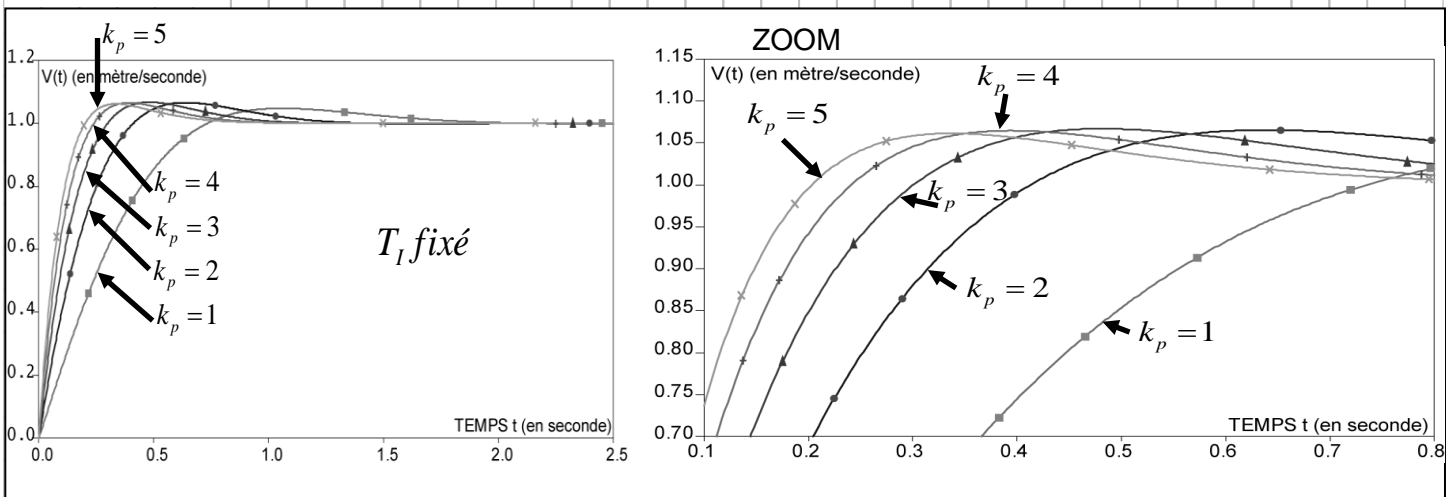

**Question 11 :**

